

An Average Current Modulation Method for Single Stage LED Drivers with High Power Factor and Zero Low Frequency Current Ripple

Brian White, *Student Member, IEEE*, Hongliang Wang, *Member, IEEE*, Yan-Fei Liu, *Fellow, IEEE*

Department of Electrical and Computer Engineering

Queen's University

Kingston, ON, Canada

b.white@queensu.ca, hongliang.wang@queensu.ca, yanfei.liu@queensu.ca

Abstract—Conventional single-stage AC-DC LED drivers with a high power factor contain significant LED current ripple at twice the AC line frequency, and require large energy storage capacitors to limit the effect on LED light. Conventional designs and novel control techniques aim to power LED loads with a DC voltage to ensure a limited low frequency current ripple. This paper proposes an average current modulation method that is capable of driving LEDs from a voltage that contains significant AC ripple, while maintaining zero low frequency current ripple. This allows the energy storage capacitance of the PFC stage to be reduced, avoiding the need for electrolytic type capacitors, and prolonging the life of the LED driver. The average current modulation circuit requires a single low voltage MOSFET, a current sense resistor and a simple control circuit. By requiring no additional magnetic components, the cost of the average current modulation circuit is very low, and has minimal impact on the efficiency of the overall LED driver. A 25 W experimental prototype with a Flyback PFC converter has been built to verify the capability and excellent performance of the proposed driving technique.

Keywords—LED lighting; energy efficiency; ripple-free; electrolytic capacitor;

I. INTRODUCTION

As a large portion of global energy produced is consumed by electric lighting, performance improvements in the field are able to deliver significant energy savings. While fluorescent lamps offer increased energy efficiency over traditional incandescent lighting, solid state lighting offers numerous benefits that will see it overtake fluorescent lighting as the dominant source of residential and commercial lighting [1, 2]. Light emitting diode (LED) lamps are a leading contender for replacing both compact fluorescent lamps, largely used in residential lighting, and fluorescent tube lamps, largely used in commercial lighting. These LED lamps offer higher luminous efficacy, longer lifetimes (50 000+ hours) and contain no hazardous materials such as Mercury.

The configuration of LED drivers has evolved to achieve high power factor (PF) and high efficiency. Energy Star regulations [3] require residential lighting to achieve 0.7 PF while commercial lighting must achieve 0.9 PF. To meet these requirements, two stage LED drivers can be implemented to

provide excellent performance. These drivers usually consist of an AC-DC power factor correction (PFC) circuit, followed by a DC-DC converter which provides a constant current to an LED lamp. This configuration requires relatively low energy storage capacitance in the PFC stage, as the DC-DC converter is able to follow a varying input voltage while still providing a constant output current. The two stage approach however, suffers from a high component count that leads to higher costs and a lower efficiency. To provide a high efficiency LED driver with acceptable performance, single stage PFC converters can be employed to power LED lamps.

Obtaining a high power factor with a single stage power converter causes an energy imbalance between the AC input and the DC output. This energy imbalance requires energy storage capacitors to balance the power difference, smoothing the resulting voltage ripple at the output. Conventionally, single stage PFC circuits that are employed as LED drivers utilize large energy storage capacitors to limit the ensuing current ripple within the LED load. This is done mainly to limit the ripple of the light produced by the LEDs. A large capacitance increases the overall cost of the LED driver, and necessitates the use of electrolytic type capacitors due to their high energy density. Electrolytic capacitors have significantly lower lifespans (~10 000 hours) than LED chips, and the use of these capacitors in LED drivers limits the overall life of the resulting LED lamp. As a long lifespan is a key attraction to LED lighting, this is undesirable. It is therefore desirable to utilize a single stage PFC circuit that can provide a low output current ripple with a reduced amount of energy storage capacitance.

Recently proposed LED drivers [4–6] have put forth altered single stage PFC drivers that can provide tightly regulated DC voltages to LED loads while using low energy storage capacitance. These works suffer from increased component costs, complicated control techniques, or relatively significant power losses.

An average current modulation method is proposed in this paper to operate in conjunction with single stage PFC drivers. The proposed method features a simple control scheme, and only requires a single low voltage MOSFET (rated same as LED output voltage) to provide zero low frequency current

ripple to an LED load. The control method does not require a DC voltage to power the LED load, thus allowing a significant reduction in the energy storage capacitance of the PFC stage. The proposed design has been experimentally tested with a Flyback prototype.

This paper is organized as follows: Section II explains the theory and operation of the proposed average current modulator, Section III showcases the experimental results, and Section IV presents the conclusions to the paper.

II. OPERATING PRINCIPLE OF THE PROPOSED AVERAGE CURRENT MODULATOR METHOD

A. Average Current Control

LED drivers based on single stage AC-DC PFC circuits contain significant output current ripple at twice the AC line frequency. The magnitude of this low frequency ripple is inversely proportional to the amount of energy storage capacitance used in the PFC stage. This low frequency current variation in the LED load produces undesirable light flicker that can cause headaches, eye strain, and even seizures in severe cases. The proposed average current modulation method (current modulator) removes the low frequency LED current ripple that is normally generated by conventional single stage PFC LED drivers.

Fig. 1 shows the average current modulator added to a single stage PFC LED driver, placed in series with the LED

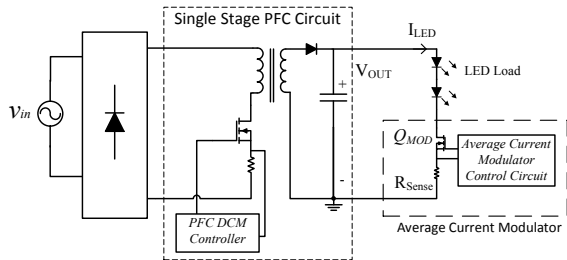

Fig. 1. Average Current Modulator within Single Stage PFC Circuit

load. The current modulator consists of a modulation switch (Q_{MOD}), current sense resistor (R_{Sense}) and a control circuit. The LED current is modulated at a fixed high modulation frequency (~ 25 kHz) by the modulation switch such that the average LED current is controlled for each modulation cycle. By doing this, the resulting LED current will consist of a DC component equal to the controlled average value, and a high frequency component at the modulation frequency. This modulation method removes any low frequency current ripple that would be induced by the voltage ripple of the PFC stage. The LED load will produce light that is proportional to the average LED current, and appear flicker-free as humans do not notice high frequency light modulation [7]. The concept of high frequency current modulation with LEDs has been explored at length in [8], with a focus on dimming applications.

By controlling the average current at a high frequency, the current modulator is able to respond to significant low frequency voltage variation of the PFC output. Therefore, the average current modulator can provide an LED current with zero low frequency content powered by PFC circuits which contain significant output voltage ripple at twice the line frequency. The PFC circuit could be implemented by numerous topologies, with or without electrical isolation. With the voltage rating for Q_{MOD} being the same as the LED voltage (which is often 100V or less), and the simple control circuit, the cost of the modulator is kept very low.

The detailed control circuit of the average current modulator is illustrated in Fig. 2. To control the average LED current in a modulation cycle, the modulator instigates the switch turn-on at the beginning of each cycle via the flip flop and fixed frequency clock. The LED current is sensed and integrated by the ‘LED Current Integrator’. Once the integrated current level equals the error voltage of the error amplifier, the modulation switch is turned off by the flip flop through the ‘Current Comparator’. The error voltage is generated by the ‘Error Amplifier’, by comparing the average LED current level, which is generated by filtering the LED current, to the current reference. The current reference is generated by the ‘Peak Duty Cycle’ control loop, and will be described in the following subsection.

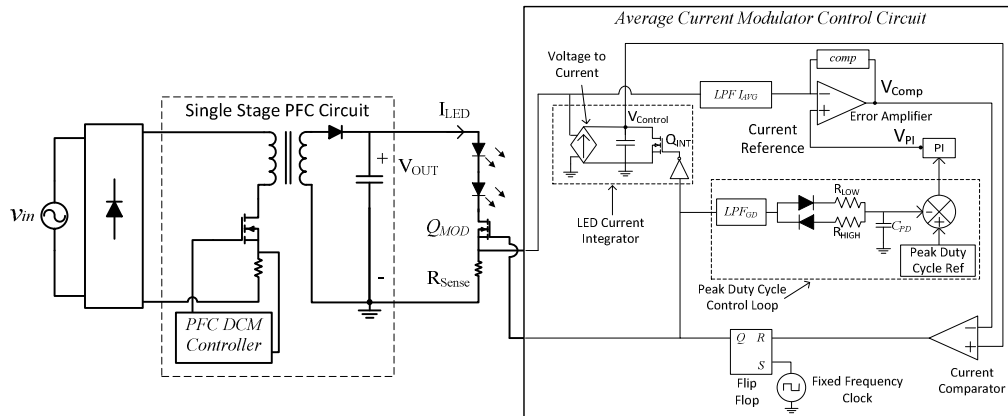

Fig. 2. Detailed Schematic of the Average Current Modulator Control Circuit

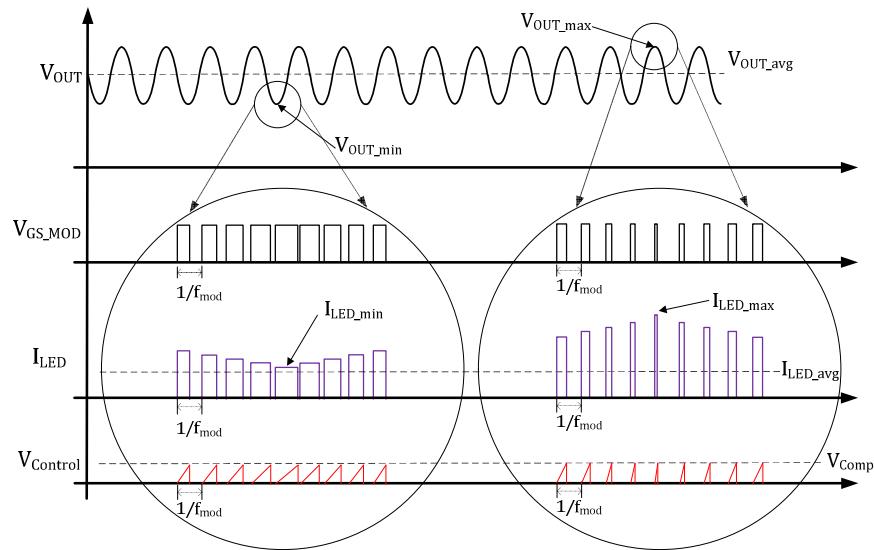

Fig. 3. Key Waveforms of the Average Current Modulator

The diagram of Fig. 3 illustrates the operation of the average current modulator by providing key waveforms that show the control of the LED current, referenced against the PFC output voltage. Fig. 3 shows the following waveforms: PFC output voltage (V_{OUT}), modulation switch gate signal (V_{GS_MOD}), LED load current (I_{LED}), and the modulation switch turn-off signal ($V_{Control}$) which is the integrated current signal for each cycle. To illustrate the two extreme operating points of the current modulator, the waveforms of Fig. 3 are zoomed in to isolate the behaviour at the maximum and minimum values of the PFC output voltage, V_{OUT_max} and V_{OUT_min} , respectively.

B. Maximum LED Current and Peak Duty Cycle

Due to the low frequency variation of the PFC output voltage, the magnitude of the LED current pulses will also vary at this low frequency. To maintain the programmed average current each modulation cycle, the duty cycle of the modulation switch will follow a sinusoidal shape with an opposite phase compared to the LED current pulses. The modulation switch duty cycle will peak at the minimum PFC output voltage, which produces the minimum LED current pulse, and will reach its minimum value at the maximum PFC output voltage, thus producing the maximum LED current pulse.

Based on recommendations from Cree [9], limits are set for the pulsed capability of LEDs based on the duty cycle and magnitude of the pulse. They recommend current pulses do not exceed 100% of the maximum rated current for duty cycles between 51% - 100%, current pulses do not exceed 200% of the rated current for duty cycles between 10% - 50% and that current pulses with less than 10% duty cycles do not exceed 300% of the rated current. It is noted that if the chosen LED load is rated for an output current twice that of the average value, then the load can tolerate current pulses above the rated current, as they will occur at duty cycles lower than 50 %.

To prevent damage to the LEDs, the maximum current pulse must be limited. It is noted that the maximum LED current pulse is offset from the minimum LED current pulse by a value that is dependent on system constants. The difference between the minimum and maximum current pulses is dictated by the average LED current, series resistance of the LED load, the capacitance used in the PFC stage and the AC frequency of the input voltage, as given in (1). It is proposed that if the minimum LED current pulse can be controlled, the maximum LED current pulse can be indirectly controlled.

The minimum LED current pulse must be large enough to produce the desired average current with a duty cycle less than 100 %. If the duty cycle of the minimum LED current pulse (the peak duty cycle) is set very high (e.g. 90 %), the minimum LED current pulse will be controlled close to its maximum value and the maximum LED current pulse will be limited.

$$I_{LED_max} - I_{LED_min} = \frac{I_{LED_avg}}{R_{LED} \cdot (2\pi \cdot f_{AC} \cdot C_{out})} \quad (1)$$

The average current modulator controls the peak duty cycle by programming its current reference based on an error signal generated by the difference between the detected peak duty cycle and the programmed peak duty cycle. The circuit of this control loop is illustrated in Fig. 2, labelled as the 'Peak Duty Cycle Control Loop'. This control loop inputs the gate signal of the modulation switch and outputs a control signal from a PI block (V_{PI}) to the error amplifier as the current reference.

When the peak duty cycle is below the desired level, V_{PI} will increase, increasing the reference of the current modulator. As the average current reference increases, the peak duty cycle will increase to achieve the higher average LED current. When the peak duty cycle is above the desired level, V_{PI} will decrease, decreasing the reference of the current modulator. As the average current reference decreases, the peak duty cycle will decrease to achieve the lower average LED current.

With the current reference of the modulator set by controlling the peak duty cycle, the LED current level is controlled by the PFC controller. If the PFC circuit changes its output current, the modulator adjusts the average LED current to maintain the programmed peak duty cycle. Thus, if the PFC circuit features dimming, the average current modulator would be compatible.

III. EXPERIMENTAL RESULTS

A prototype LED driver with a Flyback PFC stage was built to demonstrate the operation of the current modulator. The output of this prototype is designed to operate at $\sim 50\text{V} / 500\text{mA}$ for 25 W of power from a 60 Hz AC supply. The Osram LUW-W5AM LED is used to configure the LED load, rated for a maximum current of 1 A. The LED load is configured with 20 chips, exhibiting a forward voltage of 42 V and a series resistance of $13.4\ \Omega$ at 500 mA. An LED load with a 1 A current rating is selected so that the pulsed current waveform does not damage the LEDs.

The single stage Flyback PFC LED driver is designed to have significant low frequency output voltage ripple, to fully demonstrate the performance of the current modulator. The energy storage capacitance is selected such that the PFC output will carry a voltage ripple of approximately $6\text{ V}_{\text{pk-pk}}$, which is calculated to be $221\ \mu\text{F}$. Three $68\ \mu\text{F}$ capacitors are selected for a total of $204\ \mu\text{F}$. The Flyback PFC circuit is implemented with the FL7732 Primary Side Regulated PFC Controller [10] from Fairchild.

To be able to measure the ability of the average current modulator, it is important to be able to compare the performance to an alternative design. An LED driver using the conventional driver design is constructed using the same power stage and PFC control circuit. The Fast Fourier Transform (FFT) of the LED current and measured LED light is taken for both drivers. The DC and 120 Hz components are analyzed and compared.

The output LED current of the conventional driver is shown in Fig. 4, with its FFT result. The LED current has a 120 Hz ripple current of $147\text{ mA}_{\text{rms}}$ with a DC current of 515 mA. This represents a modulation index of 40%, defined as the ratio of the peak 120 Hz value to the DC value ($147\text{ mA} * 1.414 / 515\text{ mA}$). The output LED light of the conventional driver is shown in Fig. 5, with its FFT result. The LED light has a 120 Hz ripple of $452\text{ mV}_{\text{rms}}$, with a DC value of 1.68 V. This represents a modulation index of 38% ($452\text{ mV} * 1.414 / 1.68\text{ V}$).

The average current modulator is connected to the LED driver in the laboratory to reduce the low frequency current ripple of the LED load. The block diagram of the experimental prototype with the modulator added is the same as in Fig. 1. The modulator is set to a modulation frequency of 25 kHz. The modulator is configured using the UCC38C43 control IC from Texas Instruments, the IRFL014NPBFCT MOSFET from International Rectifier and a current sense resistor. The modulation MOSFET is rated for 55 V and 2 A. A peak duty cycle of 90% is programmed.

The waveform of the modulated LED current is presented in Fig. 6, along with its FFT result. Using the average current

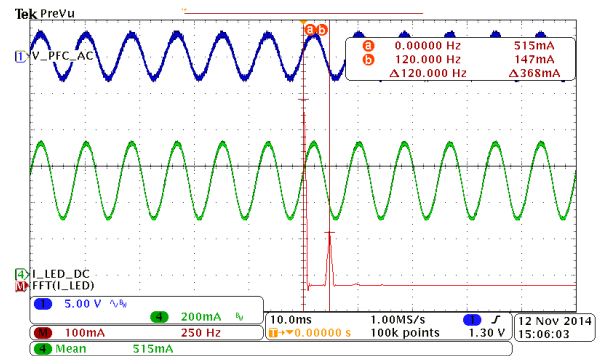

Fig. 4. Conventional Flyback LED Driver – LED Current. CH1: PFC Output Voltage (AC Coupled; 5 V/div; 10 ms/div). CH4: LED Current (DC Coupled; 200 mA/div; 10 ms/div). MATH: FFT of LED Current (100 mA/div; 250 Hz/div)

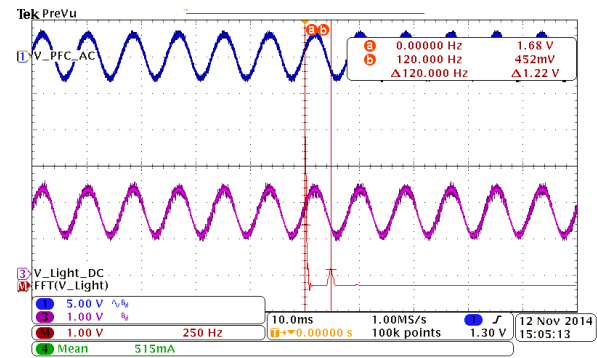

Fig. 5. Conventional Flyback LED Driver – LED Light. CH1: PFC Output Voltage (AC Coupled; 5 V/div; 10 ms/div). CH3: LED Light (DC Coupled; 1 V/div; 10 ms/div). MATH: FFT of LED Light (1 V/div; 250 Hz/div)

modulator, the 120 Hz component of the LED current has been reduced to $5.62\text{ mA}_{\text{rms}}$, with a modulation index of 1.54% ($5.62\text{ mA} * 1.414 / 514\text{ mA}$). Use of the modulator has reduced the 120 Hz current modulation index from 40% to 1.54%. The peak duty cycle of the LED current is shown in Fig. 7, where the current modulation has been zoomed in at the minimum value of the PFC output voltage. The minimum duty cycle is shown in Fig. 8, where the current modulation has been zoomed in at the maximum value of the PFC output voltage.

The waveform of the modulated LED light is presented in Fig. 9, along with its FFT result. Using the average current modulator, the 120 Hz component of the LED light modulation index is calculated to be 4.1% ($42.2\text{ mV} * 1.414 / 1.44\text{ V}$). Use of the average current modulator has reduced the 120 Hz light modulation index from 38% to 4.1%. This is well below the limit proposed in [7] for ‘Low Risk’ light flicker at 120 Hz.

Due to the non-linear relationship between LED current and luminous flux, the low frequency light ripple has not been completely eliminated. The peak duty cycle of the LED light is shown in Fig. 10, where the light modulation has been zoomed in at the minimum value of the PFC output voltage. The minimum duty cycle is shown in Fig. 11, where the light modulation has been zoomed in at the maximum value of the PFC output voltage.

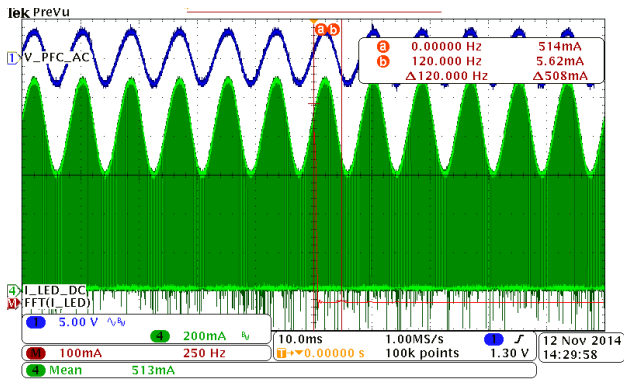

Fig. 6. Flyback output voltage ripple and LED current with average current modulator. CH1: PFC output voltage (ac coupled; 5 V/div; 10 ms/div). CH4: LED current (dc coupled; 100 mA/div; 10 ms/div). MATH: FFT of LED current (50 mA/div; 250 Hz/div).

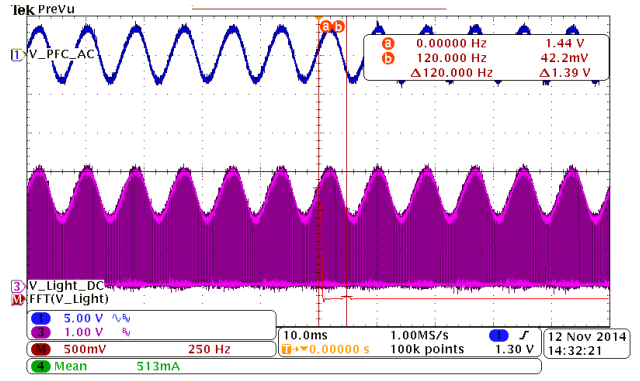

Fig. 9. Flyback output voltage ripple and LED light with average current modulator. CH1: PFC output voltage (ac coupled; 5 V/div; 10 s/div). CH4: LED light (dc coupled; 100 mA/div; 10 ms/div). MATH: FFT of LED current (50 mA/div; 250 Hz/div).

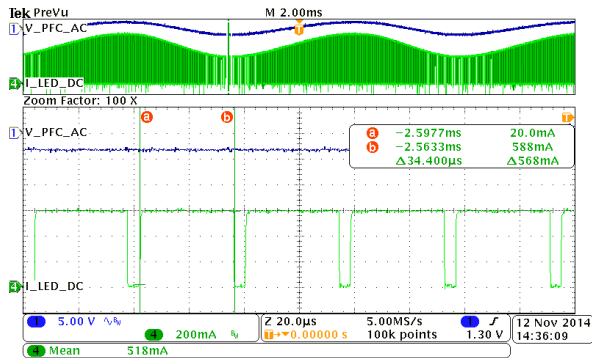

Fig. 7. LED current highlighting peak duty cycle. CH1: PFC output voltage (ac coupled; 5 V/div; 20 μ s/div). CH4: LED current (dc coupled; 100 mA/div; 20 μ s/div).

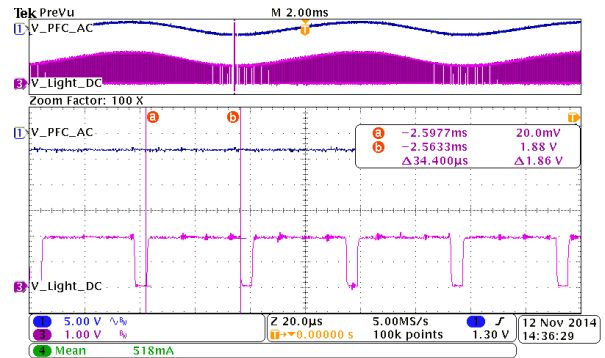

Fig. 10. LED light highlighting peak duty cycle. CH1: PFC output voltage (ac coupled; 5 V/div; 20 μ s/div). CH4: LED light (dc coupled; 100 A/div; 20 μ s/div).

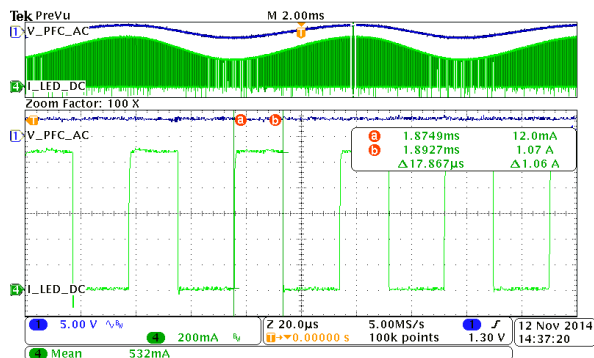

Fig. 8. LED current highlighting minimum duty cycle. CH1: PFC output voltage (ac coupled; 5 V/div; 20 μ s/div). CH4: LED current (dc coupled; 100 mA/div; 20 μ s/div).

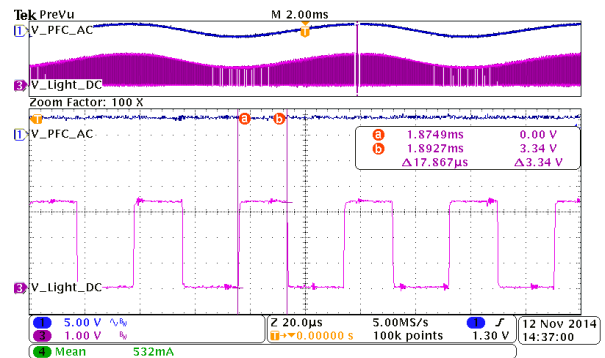

Fig. 11. LED light highlighting minimum duty cycle. CH1: PFC output voltage (ac coupled; 5 V/div; 20 μ s/div). CH4: LED light (dc coupled; 100 mA/div; 20 μ s/div).

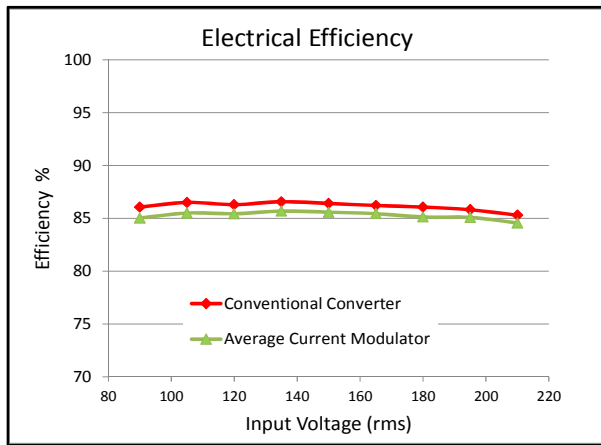

Fig. 12. Efficiency comparison with and without average current modulator

The efficiency of both the conventional Flyback driver and the efficiency of the Flyback driver with the average current modulator added are measured, and displayed in Fig. 12. It is found that there is less than 1% drop when the modulator is added. The power factor of both drivers is also measured, displayed in Fig. 13, and it is found that there is no discernible change between the two configurations.

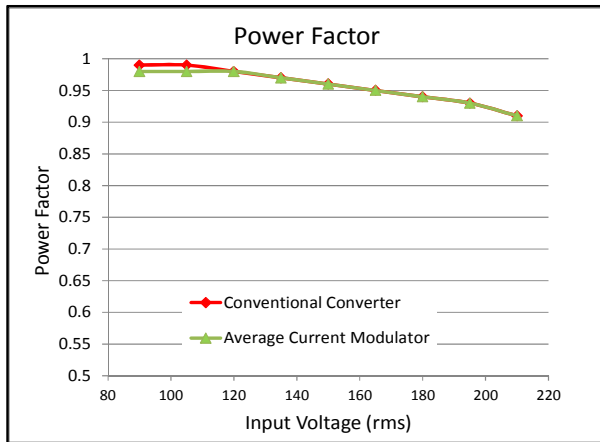

Fig. 13. Power factor comparison with and without average current modulator

IV. CONCLUSION

The average current modulation method proposed within this paper presents a novel control technique for driving LEDs from single stage PFC circuits. It provides minimized low frequency LED current with reduced PFC energy storage capacitance, allowing the use of ceramic or film type capacitors for long lamp lifetime. A peak duty cycle control method is implemented within the average current modulator to limit the maximum LED current pulse, preventing damage to the LED load. Experimental results of a lab tested prototype show that the low frequency current ripple can be limited to 1.5%, and that the low frequency light ripple is limited below the tolerated boundaries defined by the industry. The component cost of the modulator is very low, requiring only a single low voltage MOSFET, current sense resistor and simple control circuit. The modulator has a limited effect on efficiency, with less than 1% drop when compared to conventional LED drivers, and has a negligible impact on the power factor of the LED driver.

REFERENCES

- [1] "GE Lighting Sees Brighter Future With LED Growth" *forbes.com*, last modified June 11 2013,
- [2] IMS Research, "\$10bn Market for LED Power Supplies in 2016" *lighting.com*
- [3] Standard: ENERGY STAR Qualifying Criteria for Solid Stage Lighting (SSL) Luminaires, Version 1.3, U.S. EPA, 2010
- [4] Yan-Cun Li; Chern-Lin Chen, "A Novel Single-Stage High-Power-Factor AC-to-DC LED Driving Circuit With Leakage Inductance Energy Recycling," *Industrial Electronics, IEEE Transactions on*, vol.59, no.2, pp.793,802, Feb. 2012
- [5] Yajie Qiu; Hongliang Wang; Zhiyuan Hu; Laili Wang; Yan-Fei Liu; Sen, P.C., "Electrolytic-capacitor-less high-power LED driver," *Energy Conversion Congress and Exposition (ECCE)*, 2014 IEEE, vol., no., pp.3612,3619, 14-18 Sept. 2014
- [6] Peng Fang; White, B.; Fiorentino, C.; Yan-Fei Liu, "Zero ripple single stage AC-DC LED driver with unity power factor," *Energy Conversion Congress and Exposition (ECCE)*, 2013 IEEE, vol., no., pp.3452,3458, 15-19 Sept. 2013
- [7] B. Lehman; A. Wilkins; S. Berman; M. Poplawski; N.J. Miller, "Proposing measures of flicker in the low frequencies for lighting applications," *Energy Conversion Congress and Exposition (ECCE)*, 2011 IEEE, vol., no., pp.2865,2872, 17-22 Sept. 2011
- [8] D. Gacio; J.M. Alonso; J. Garcia; L. Campa; M.J. Crespo; M. Rico-Secades, "PWM Series Dimming for Slow-Dynamics HPF LED Drivers: the High-Frequency Approach," *Industrial Electronics, IEEE Transactions on*, vol.59, no.4, pp.1717,1727, April 2012
- [9] Cree Inc., "Application Note: Pulsed over-current driving of XLamp LEDs", Aug 2012
- [10] Fairchild Semiconductor, Datasheet "FL7732, Single-Stage PFC Primary Side Regulation Offline Driver", Oct 2012